

SURROUNDS

S11

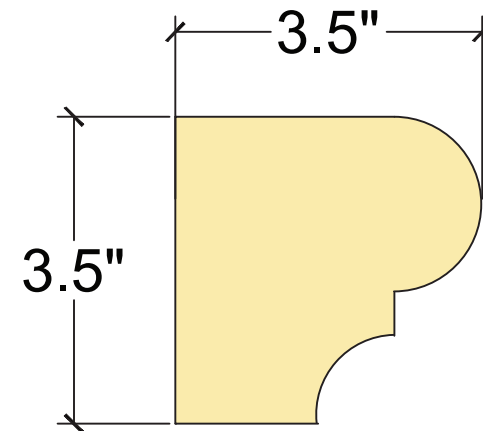
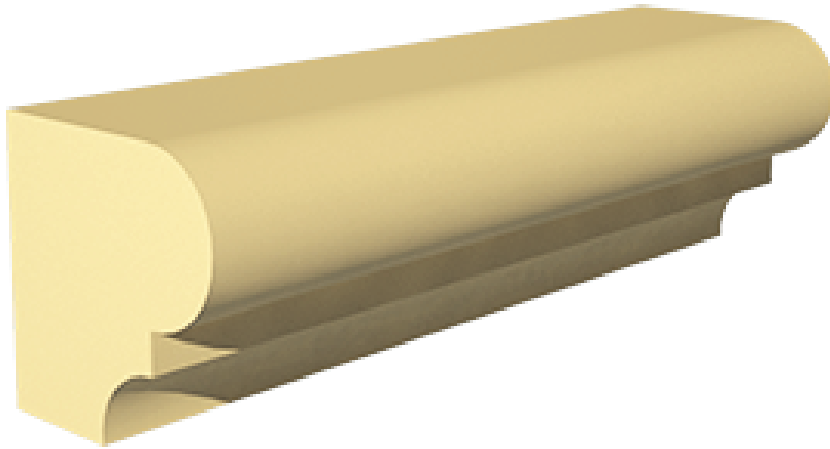

ALL STANDARD 4' LONG

BROOKLYN
5223 FIRST AVENUE
BROOKLYN, NY 11232
TEL: 718-630-5300
FAX: 718-630-5320

LONG ISLAND
275 EDISON AVENUE
WEST BABYLON, NY 11704
TEL: 631-577-1800
FAX: 631-577-1811



available only at
WALL SYSTEMS SUPPLY

STATEN ISLAND
3521 VICTORY BLVD
STATEN ISLAND, NY 10314
TEL: 718-494-2500
FAX: 718-494-2600

NEW JERSEY
575 PROSPECT ST UNIT 230C
LAKEWOOD, NJ 08701
TEL: 732-364-2626
FAX: 732-364-4012