

# SURROUNDS

## S22

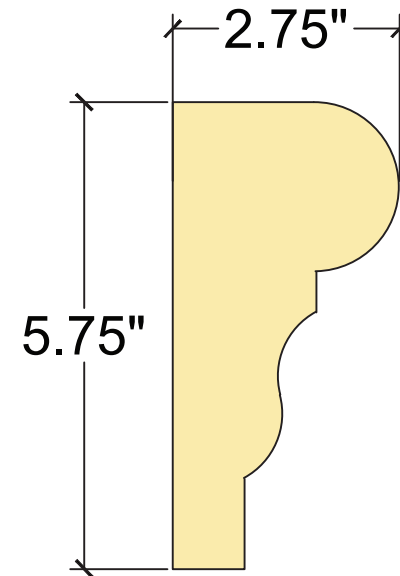
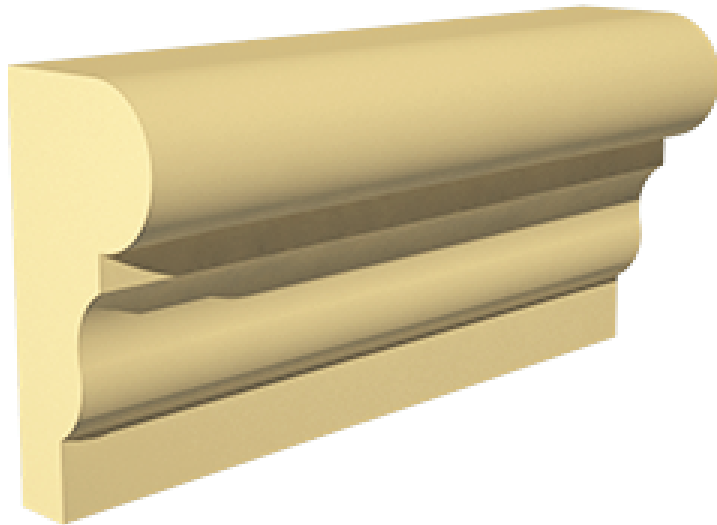

**ALL STANDARD 4' LONG**

**BROOKLYN**  
5223 FIRST AVENUE  
BROOKLYN, NY 11232  
TEL: 718-630-5300  
FAX: 718-630-5320

**LONG ISLAND**  
275 EDISON AVENUE  
WEST BABYLON, NY 11704  
TEL: 631-577-1800  
FAX: 631-577-1811



available only at  
**WALL SYSTEMS SUPPLY**

**STATEN ISLAND**  
3521 VICTORY BLVD  
STATEN ISLAND, NY 10314  
TEL: 718-494-2500  
FAX: 718-494-2600

**NEW JERSEY**  
575 PROSPECT ST UNIT 230C  
LAKEWOOD, NJ 08701  
TEL: 732-364-2626  
FAX: 732-364-4012